

MULTIFUNCTION FENCE & STOP SET ASSEMBLY INSTRUCTIONS



Thanks for purchasing this genuine TSO Product.
Questions? Suggestions? Ideas? We thrive on your feedback!
Contact us toll-free at 800-727-0311 (U.S.), 239-236-5526
(international), email us at info@tsoproducts.com, or visit
www.tsoproducts.com/support for a copy of this guide.

⚠ DANGER

Danger indicates a hazardous situation that, if not avoided, will result in death or serious injury.

⚠ WARNING

Warning indicates a hazardous situation that, if not avoided, could result in death or serious injury.

⚠ CAUTION

Caution indicates a hazardous situation that, if not avoided, may result in minor or moderate injury or property damage.

NOTICE

Notice indicates important or helpful information and/or user tips.

ESSENTIAL SAFETY WARNINGS

This product is intended and designed for use only with the Festool® MFT/3 MultiFunction Table or other work surfaces that share the standard 20mm x 96mm hole pattern. The Festool Instruction Manual for the MFT/3 also applies when using this TSO Products MultiFunction Fence & Stop Set. Ensure that the included Fence Dogs are properly inserted into the table holes. If additional fence clamping is required, secure from underneath the table with M8 SpeedKnobs or similar M8 clamping knobs. Failure to do so may result in product damage, inaccurate cuts or injury.

⚠ CAUTION

The content of this assembly guide is provided solely for the purpose of assembling the product. It is not intended to serve as a comprehensive instruction manual or to provide guidance on the safe operation of power tools, including but not limited to saws. Users are expected to have full knowledge of and adhere to the safety and operational instructions provided by the manufacturer of any power tools they operate.

Failure to consult the manufacturer's original instructions for safe operation and handling of power tools may result in serious injury, damage, or death. The manufacturer of this product and the author of this assembly guide assume no liability for any injuries or damages arising from improper use of power tools or failure to follow appropriate safety procedures. Always refer to and follow the specific safety guidelines provided by the manufacturer of your tools.

Woodworking involves a variety of injury risks which you can reduce with proper use of Personal Protective Equipment (PPE) and adherence to safe work practices.

MULTIFUNCTION FENCE & STOP SET ASSEMBLY INSTRUCTIONS

Contents

Tools Needed for Assembly	2
What's Included in the Box	2
Additional Compatible Accessories	2
Should You Install the Fence Upright or Flat?	2
Setup Fence in Upright Position	2
Setup Fence as Straight Edge Guide	4
Setup Fence in Cantilevered Position	5
Setup Fence in Angled Positions	6
Questions, Comments, or Ideas?	7

Tools Needed for Assembly

Use the following additional tools to complete all installation steps:

- **5mm Hex Driver**—For securing Fence Dogs to Fence Extrusion
- 2 qty. **M8 Clamping Knobs**—For securing Fence Dogs to 20x96mm hole patterned worktop.
- **Combination Square**—Optional, but makes it easier to calibrate Fence scale. Alternatively, a scrap piece of wood or panel cut to 7-7/8" long.

What's Included in the Box

Ensure you have the following parts and quantities:

Parts List			
			
1 qty. Fence	2 qty. Fence Dogs ¹	1 qty. Flip-Stop	1 qty. Material Support Plate & Dog ¹

¹ Optional washer for use with clamping knobs in thinner worktops. Optional M6 square nut fits into the middle, smaller T-slot in the extrusion.

Additional Compatible Accessories

While not included in the MultiFunction Fence & Stop Set, these accessories can be helpful for specific use cases:

- **M8 SpeedKnobs**—For anchoring Fence Dogs to table
- **Fence-to-Triangle Connector**—For attaching Fence Extrusion to TSO Precision Triangles
- **Stock Support & Stop Bracket**—For securing workpieces that extend beyond the work surface
- **Additional FlipStops**—Handy if you frequently go between multiple common cutting lengths.

- **Additional Fence Segments**—Expand by adding stand-alone fence lengths.
- **Additional Fence Dogs**—For additional fence segments or if additional support is desired.
- **Fence Connectors**—For linking multiple TSO Multi-function Fence segments.

Should You Install the Fence Upright or Flat?

When used as a fence for a Festool® MFT/3 or similar worktop, install the fence upright. In this position, the metric and imperial laser-engraved scales are visible and cut lengths easily set with the included Flip-Stop.

When used as a router or Domino guide, install the fence in the flat position. In this position, the engraved scale is imperial only, and starts from zero. Here, the Flip-Stop can be used as a router or Domino stop.

Setup Fence in Upright Position

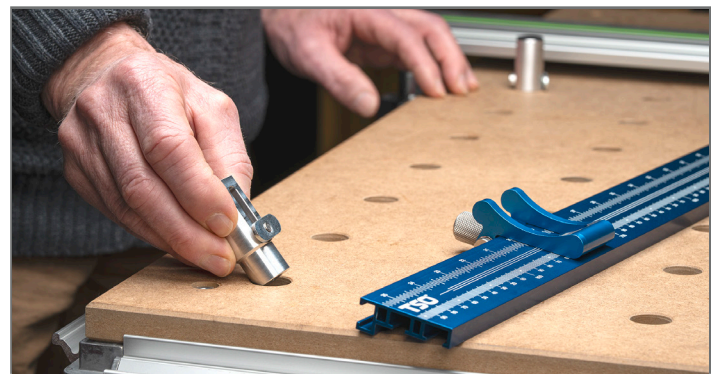

Step 1. With your guide rail installed and flat on your worktop, choose your preferred fence location. Typically, to maximize your table's cutting envelope, this will be the furthest row of dog holes. Space each Fence Dog as far apart as possible.



Step 2. Optionally, clamp both Fence Dogs from underneath the table, using **M8 SpeedKnobs** or a similar M8 clamping knob. (Clamping knobs sold separately.)

MULTIFUNCTION FENCE & STOP SET ASSEMBLY INSTRUCTIONS



Step 3. Slide the Fence Extrusion through the Torpedo Nut on both Fence Dogs, using the bottom (large) T-slot on the back of the Fence Extrusion. Position the Fence Extrusion so that it is approximately 3/8" (10mm) from the track saw guide rail. *Do not tighten Fence Dogs yet.*



Step 6. Slide the FlipStop onto the Fence Extrusion, using the upper T-slot. Position to desired cut length, and tighten the knurled knob to fix in position.



Step 4. Using a Combination Square set to 7-7/8" (200mm), slide it under the Guide Rail until the square's head touches the splinterguard. Then, slide the Fence Extrusion until it makes contact with the end of the Combination Square blade. As an alternative to a Combination Square, you can use a scrap piece of wood or panel cut to 7-7/8" long.



Step 7. Insert the Undermount Support Plate beneath your guide rail, so that the front edge of the plate is coplanar with the Fence Extrusion.



Step 5. Gently tighten both Fence Dogs screws using an M5 Hex Driver.

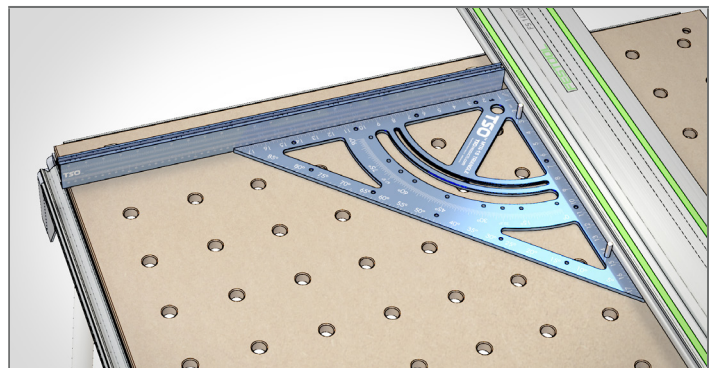

Step 8. Verify your fence is square to your guide rail before making a cut, using a **TSO Precision Triangle**, large square, or a known square panel.

MULTIFUNCTION FENCE & STOP SET ASSEMBLY INSTRUCTIONS

Setup Fence as Straight Edge Guide

⚠ CAUTION

When positioning the TSO MultiFunction Fence on top of your workpiece, ensure the material is no more than ¾" (19mm) thick. Thicker workpieces may prevent the Fence Dogs from fully seating in their 20mm dog holes, potentially compromising fence stability and increasing the risk of injury.



Step 1. Choose your preferred fence location. When using as a routing or Domino guide, position them on either side of your workpiece.



Step 2. Optionally, clamp both Fence Dogs from underneath the table, using M8 SpeedKnobs or a similar M8 clamping knob. (Clamping knobs sold separately.)

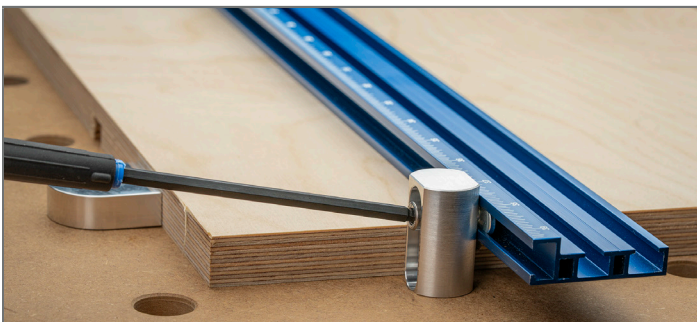

Step 3. Slide the Fence Extrusion through the torpedo nuts on both Fence Dogs and, once in position, tighten both Fence Dogs screws using an M5 Hex Driver.



Step 4. Optionally, the included Flip-Stop can be used as a router or Domino stop.

MULTIFUNCTION FENCE & STOP SET ASSEMBLY INSTRUCTIONS

Setup Fence in Cantilevered Position

⚠ CAUTION

Using the TSO MultiFunction Fence in an extended or cantilevered position can lead to product damage or personal injury due to tipping or falling from the work surface. To reduce this risk, never cantilever more than one-third of the fence's total length. Additionally, always ensure both Fence Dogs are fully inserted and securely clamped from underneath the table using compatible M8 clamping knobs (sold separately), such as [TSO M8 SpeedKnobs](#) or Festool M8 clamping knobs.

When working with thinner materials that extend beyond the edge of the table, be aware that deflection may occur. This can lead to inaccurate cuts and increased risk of injury. To reduce deflection, use the optional [TSO Material Support Bracket](#). Always ensure extended workpieces are properly supported before any cut.

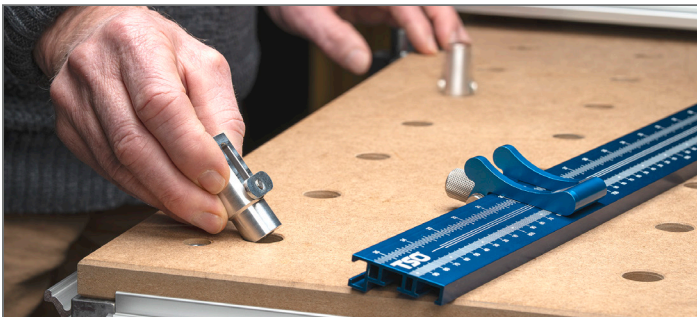

Step 1. With your guide rail installed and flat on your worktop, insert both Fence Dogs corresponding to your preferred fence location.



Step 2. IMPORTANT: Always clamp both Fence Dogs securely from underneath the table using [M8 SpeedKnobs](#) or equivalent M8 clamping knobs. Failure to properly secure the Fence Dogs may result in product damage or unsafe operation. (Clamping knobs sold separately.)



Step 3. Slide the Fence Extrusion through the torpedo nuts on both Fence Dogs.

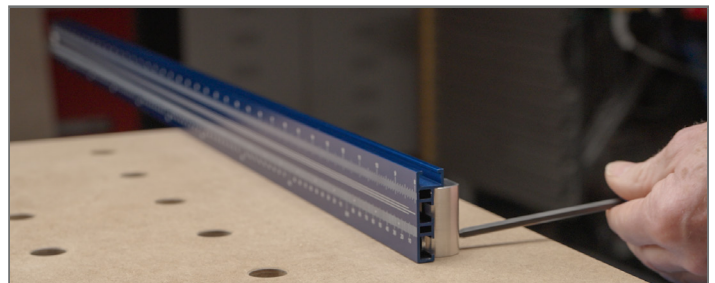

Step 4. Gently tighten both Fence Dogs screws using an M5 Hex Driver.

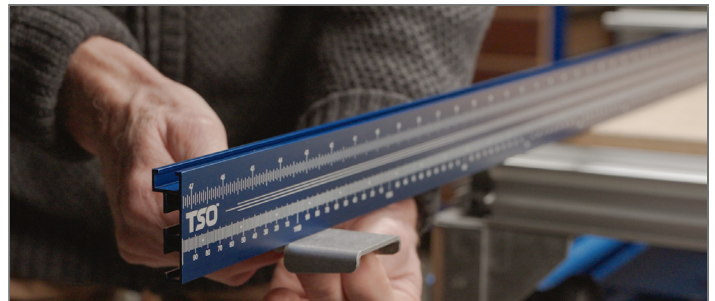

Step 5. Attach the [Stock Support & Stop Bracket](#) (sold separately) to the bottom T-slot of the Fence Extrusion.

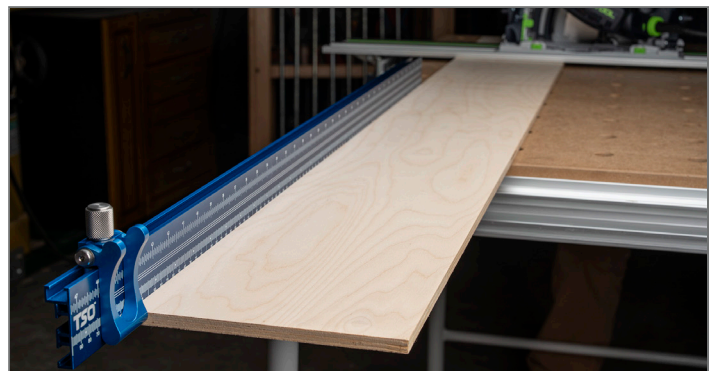

Step 6. Slide the Flip-Stop onto the Fence Extrusion, using the upper T-slot. Position to desired cut length, and tighten the knurled knob to fix in position.

MULTIFUNCTION FENCE & STOP SET ASSEMBLY INSTRUCTIONS

Setup Fence in Angled Positions

There are two methods to installing the TSO MultiFunction Fence at an angle:

- For 45° Cuts—Position the two Fence Dogs at a 45 degree angle with respect to the Guide Rail. If using a Festool MFT/3 or similar worktop that shares the 20x96mm hole pattern, this is quick and precise, but does not support custom/fine angle setting.
- For Custom/Precise Angled Cuts—The [TSO Fence-to-Triangle Connector](#) provides a reliable method to attach the Fence to any TSO Precision Triangle. In the steps below, we will show how to attach the Fence to an [MTR-X Precision Compact Triangle](#).

⚠ CAUTION

Using the [TSO Fence-to-Triangle Connector](#) replaces the Fence Dogs as the table attachment method. Because the Fence Extrusion is no longer supported on its far ends, be sure to test for deflection. If deflection is found, secure the ends of the Fence Extrusions with clamps or backer blocks.



Step 2. Install the protractor assembly included with the [MTR-X Precision Triangle](#) and secure to table at the desired angle. Slide Fence Extrusion through the two Square Nuts on the Connector. With the Fence positioned as desired, tighten the two comfort grip knobs on the Connector. Tighten the two red knobs on the MTR-X protractor.

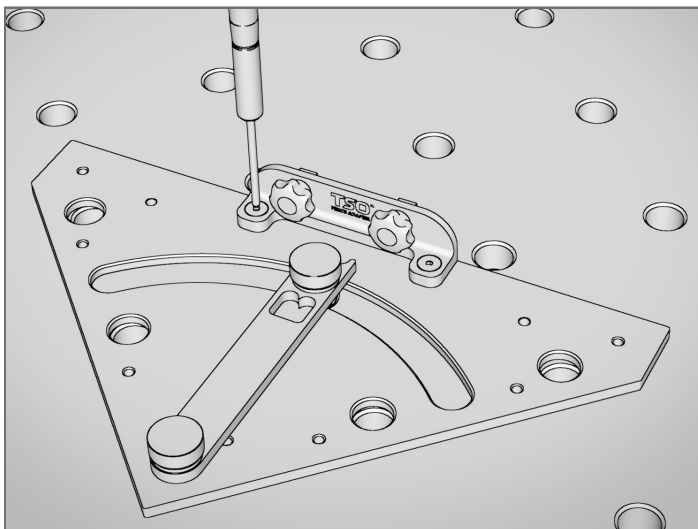

Step 1. Using a [3mm Hex Driver](#), attach the connector to the face of the MTR-X Triangle, along its long edge.



Step 3. To adjust Fence angle, loosen the two red knobs on the MTR-X protractor and rotate the Fence and Triangle Assembly to any angle. Secure in place by re-tightening both red knobs on the MTR-X protractor.

MULTIFUNCTION FENCE & STOP SET ASSEMBLY INSTRUCTIONS

TSO[™] PRODUCTS

Questions, Comments, or Ideas?

We thrive on your feedback, so please let us know if you have any comments, concerns, feedback, or ideas on how we can continuously improve our products.

We're easy to reach! In the United States, call us toll-free at 800-727-0311. For our international customers, call us at 239-236-5526. To send us a message, visit us at www.tsoproducts.com or email info@tsoproducts.com, and we'll get back to you as soon as possible.

Festool is a registered trademark of TTS Tooltechnic Systems AG & Co.